

MCL6-1000 SPECIFICATIONS

The MCL6 is designed to measure cutting tool forces during turning operations, such as in a lathe, and features a tool holder mounting fixture. The instrument has a top mounting surface (6.5 inches square) equipped with mounting holes and threaded inserts for convenient attachments of other devices. A high-strength anodized aluminum alloy (7075-T6) is used for the top plate and a corrosion resistant steel base provides added mounting stiffness for non-fully supported mounting. The tool holder standard size is 1" square. Elastomeric O-ring seals protect the strain gages and wiring and internal coating of the strain gages further ensures long life and consistent, reliable performance.



Units: Capacity:

Dimensions(WxLxH)	165 x 165 x 105 mm	IP Rating	IPNull
Weight	18.18 kg	Sensing elements	Strain gage bridge
Channels	Fx, Fy, Fz, Mx, My, Mz	Amplifier	Required
Body Material	Steel	Analog outputs	6 Channels
Temperature range	-17.78 to 51.67°C	Digital outputs	None
Excitation	10V maximum	Crosstalk	< 2% on all channels
Fx, Fy, Fz hysteresis	± 0.2% full scale output	Fx, Fy, Fz non-linearity	± 0.2% full scale output

Channel	Fx	Fy	Fz	Units	Mx	My	Mz	Units
Capacity	2224	2224	4448	N	339	339	169	N-m
Sensitivity	0.674	0.674	0.171	µv/v-N	7.53	7.53	13.28	µv/v-N-m
Natural frequency	550	550	620	Hz	-	-	-	Hz
Stiffness (X 105)	210	210	1403	N/m	-	-	-	N-m/rad

Resolution [To determine the resolution of your system, please use our Output Calculator.](#)

Published specifications subject to change without notice.

Last modified:2016-08-23

TECHNICAL DRAWINGS

Footprint Drawing (click on image to enlarge)

Electrical Drawing (click on image to enlarge)

TECHNICAL DRAWING

Footprint Drawing

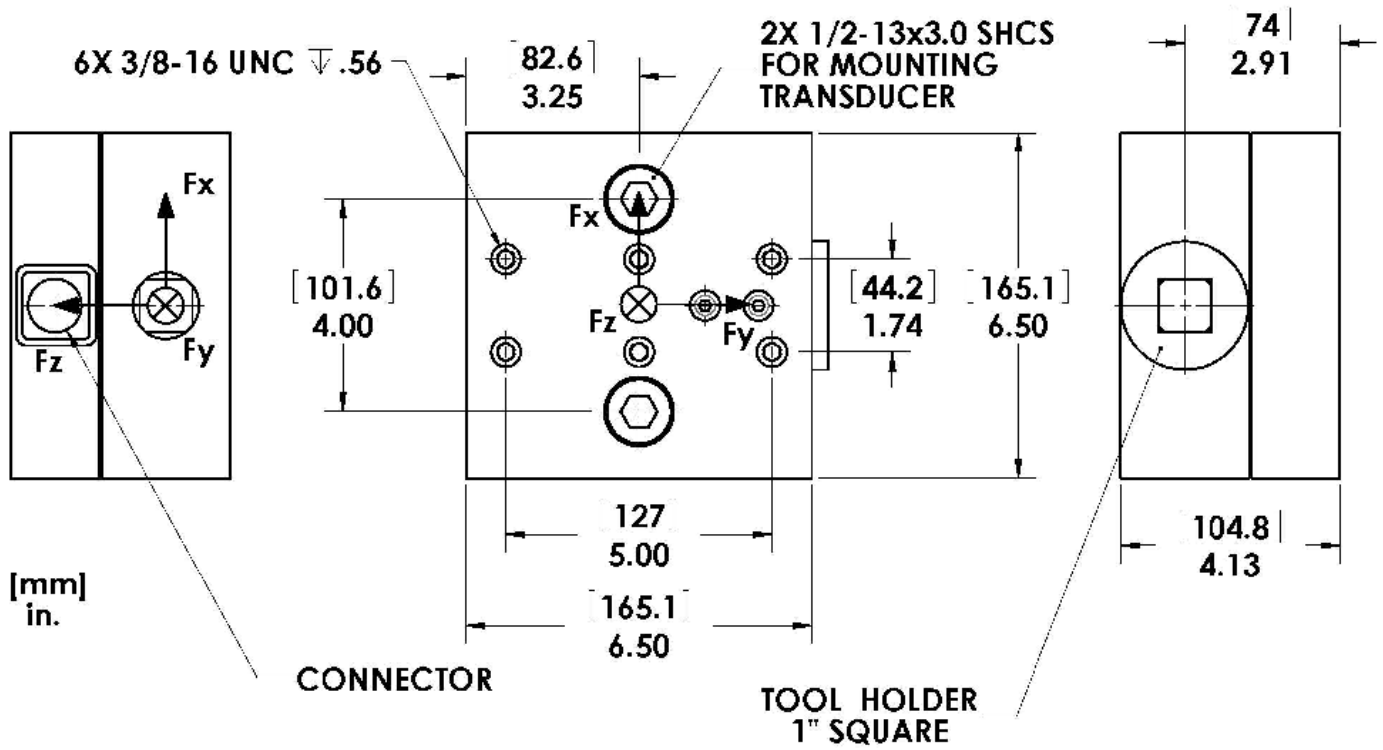

Electrical Drawing

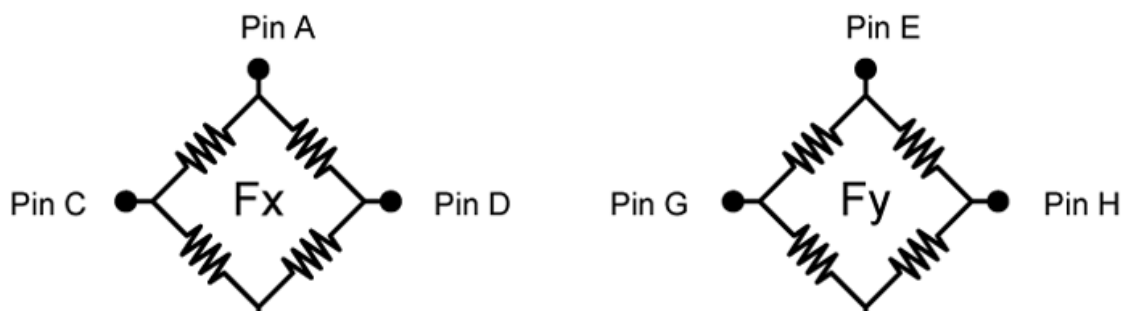
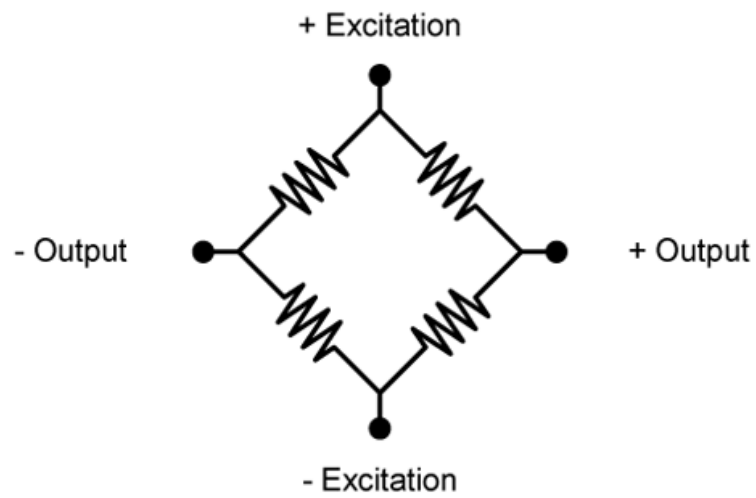

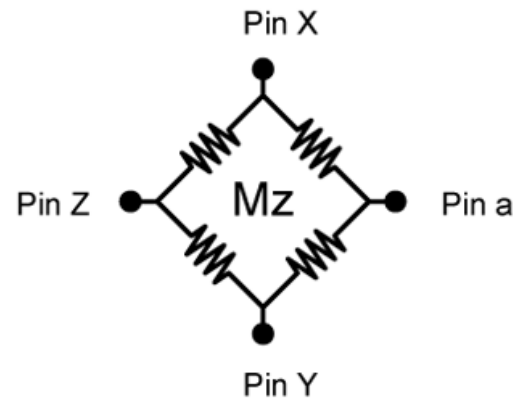
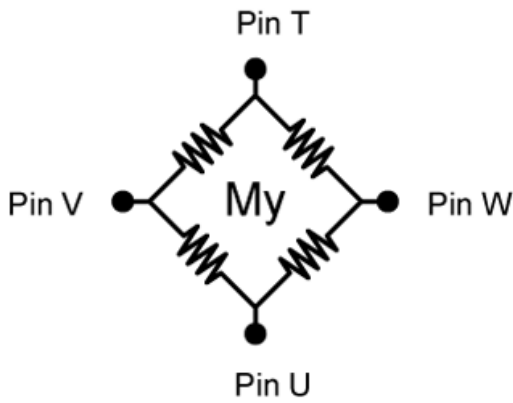
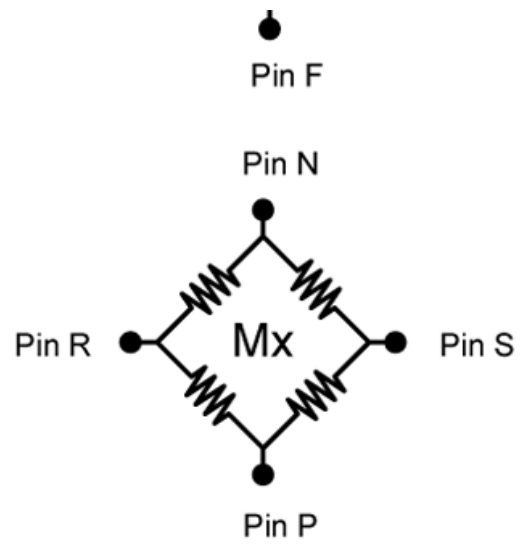
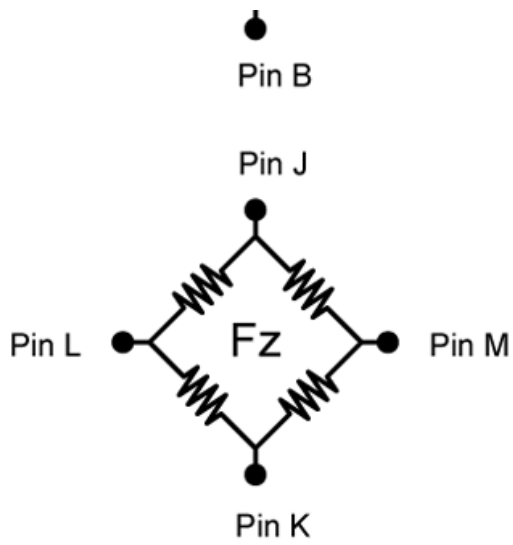

Bridge Fz = 350 ohms
 Bridges Fx; Fy; Mx; My; Mz = 700 ohms
Connector Type:
 Souriau 851-02E16-26P50-44